

Motor Running & Motor Starting Lamp Power Factor



Capacitors



Iskra[®]
Iskra MIS

Contents

General information on Iskra Capacitors

Type	Construction of capacitors	Page
KNM70xx 80xx 90xx	metallized polypropylene film capacitor (Motor Running Capacitors)	5
KNM12xx 22xx 32xx	metallized polypropylene film capacitor (Motor Running Capacitors)	9
KNM31xx	metallized polypropylene film capacitor (Motor Running Capacitors)	13
KNM31xx	metallized polypropylene film capacitor (Motor Starting Capacitors)	17
KNF50xx	metallized polypropylene film capacitor (Lamp Power Factor Capacitors)	21
KNF61xx	metallized polypropylene film capacitor (Lamp Power Factor Capacitors)	24

Motor Running & Motor Starting Capacitors KNM

Applications

Motor running capacitors type KNM are designed for obtaining an auxiliary phase in single-phase and in three-phase motors

connected to a single phase. The capacitors provide a starting moment of 25 % to 30 % of rated moment.

The approximate values of capacitors with the respect to motor power are given on the draft below.

Selection of capacitors values for different voltages and motor power

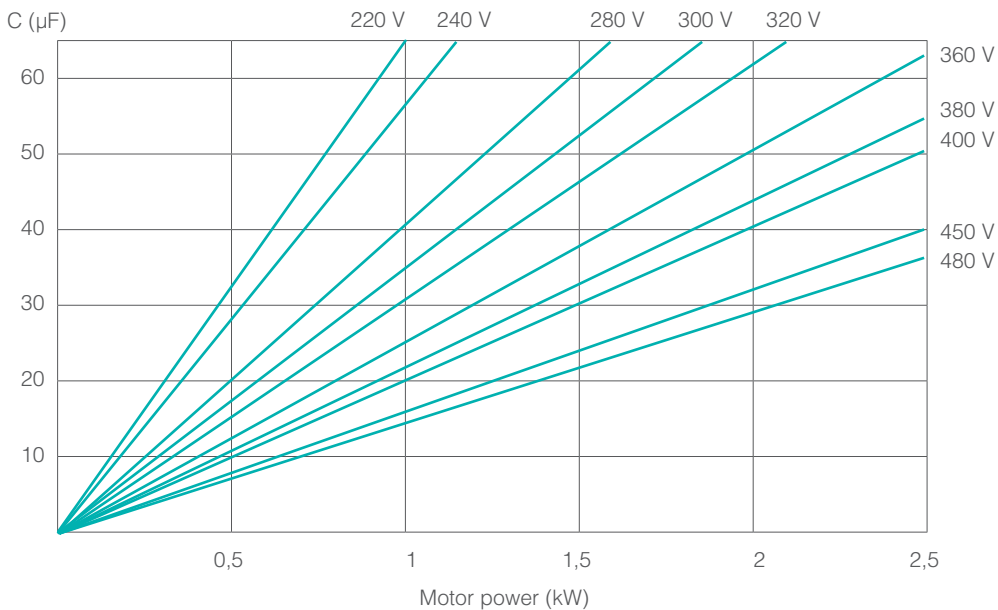

The connection and operation of single-phase motors with capacitor

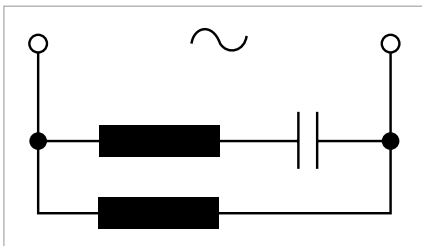

Motor running capacitor

The capacitor is connected for the entire time the motor is in operation.

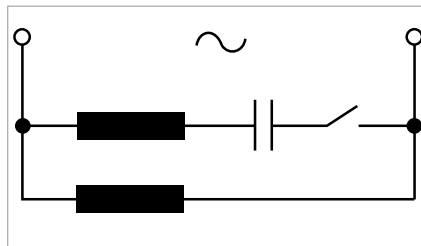

Motor starting capacitor

The capacitor is connected in series with the auxiliary motor winding only, it operates for short periods of time (3 s max.) and is automatically switched off using a centrifugal switch or electromagnetic relay as soon as the motor has built up speed.

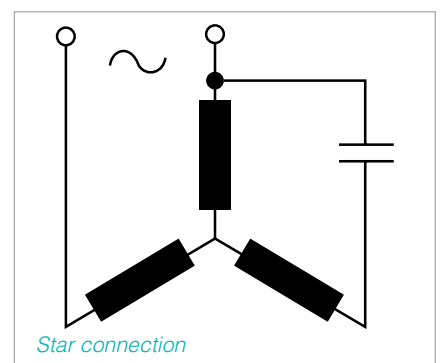
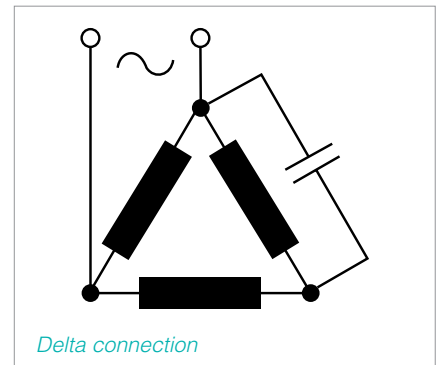

Connecting three-phase motors to a single-phase power supply

Motor Running Capacitors

Type KNM70xx

Type KNM80xx

Type KNM90xx

Safety class **P2**



TECHNICAL DATA

Rated voltage U_n :	as per table
Rated capacitance C_n :	as per table
Capacitance tolerance:	$\pm 10\%$ ($\pm 5\%$ on request)
Rated frequency f_n :	50 to 60 Hz
Loss angle $\tan\delta$:	$\max. 10 \times 10^{-4}$ at U_n and 50 Hz
Test voltage terminal to terminal:	$2 \times U_n$, 50 Hz, 2 s
Test voltage terminal to case:	2400 V, 50 Hz, 2 s
Class of operation:	as per table
Climate class:	according to EN 60252-1
Temperature range:	- 25 °C to + 85 °C
Compliance with standards:	EN 60252-1, UL 810 CSA C22.2 No. 190

Design



Motor running capacitors type KNM70xx, KNM80xx and KNM90xx are made of metallized polypropylene film. The protection against climatic and mechanical influence is reached by using aluminium can and thermoplastic cover as a casing. The capacitors are impregnated with plant oil (non PCB) and protected with a mechanical disconnecter. The leads are designed as soldering tags, two-wire cable lead and single or double fast-on tags.

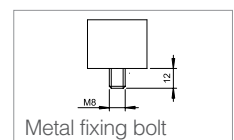

Standard designs of capacitors type KNM70xx, KNM80xx and KNM90xx

With bolt	KNM7011, 8011, 9011	KNM7011, 8011, 9011	KNM7015, 8015, 9015	KNM7017, 8017, 9017						
Without bolt	KNM7010, 8010, 9010	KNM7010, 8010, 9010	KNM7014, 8014, 9014	KNM7016, 8016, 9016						
	<p>Soldering tags D = 25mm to 55mm</p>	<table border="1"> <thead> <tr> <th></th> <th>H1(mm)</th> </tr> </thead> <tbody> <tr> <td>Aluminium cap</td> <td>18</td> </tr> <tr> <td>Plastic cap</td> <td>12</td> </tr> </tbody> </table>		H1(mm)	Aluminium cap	18	Plastic cap	12	<p>Double Fast-on D=30mm to 55mm</p>	<p>Single Fast-on D=25mm to 55mm</p>
	H1(mm)									
Aluminium cap	18									
Plastic cap	12									





Standard values and dimensions of capacitors type KNM70xx

Capacitance C (µF)	Approvals	 P2 EN 60252-1	 C22.2 No.190
	Voltage Climate class	400 VAC 50/60 Hz 10.000 h 25/85/21	240 VAC 50/60 Hz 10.000 AFC -25/+70 °C
	Type	KNM7010, KNM7011 KNM7016, KNM7017	
C (µF)	D × H (mm)	KNM7014, KNM7015 (D ≥ 30 mm)	
1	25 × 56	•	
1,5	25 × 56	•	
2	25 × 56	•	
2,5	25 × 56	•	
3	25 × 56	•	
3	35 × 56		•
3,5	25 × 56	•	
4	25 × 61	•	
4	35 × 56		•
4,5	30 × 56	•	
5	30 × 56	•	
5	35 × 56		•
6	30 × 61	•	
6	35 × 56		•
7	30 × 61	•	
7	35 × 61		•
7,5	35 × 56	•	
8	30 × 75	•	
8	35 × 56	•	
8	35 × 61		•
9	30 × 75	•	
9	35 × 61	•	•
10	30 × 75	•	
10	35 × 61	•	•
11	30 × 88	•	
12	30 × 88	•	
12	40 × 61		•
12,5	30 × 88	•	
13	35 × 75	•	
13,5	35 × 75	•	
14	35 × 75	•	•
14	40 × 61		•
15	35 × 75	•	

Capacitance C (µF)	Approvals	 P2 EN 60252-1	 C22.2 No.190
	Voltage Climate class	400 VAC 50/60 Hz 10.000 h 25/85/21	240 VAC 50/60 Hz 10.000 AFC -25/+70 °C
	Type	KNM7010, KNM7011 KNM7016, KNM7017	
C (µF)	D × H (mm)	KNM7014, KNM7015 (D ≥ 30 mm)	
16	40 × 75		•
18	35 × 88	•	•
20	35 × 88	•	•
22	40 × 75	•	
25	40 × 88	•	•
30	45 × 88	•	•
35	45 × 88	•	•
40	45 × 100	•	•
45	45 × 109	•	•
50	45 × 109	•	•
55	50 × 109	•	•
60	50 × 109	•	•
65	50 × 109	•	
65	55 × 109		•
70	55 × 109	•	•

Standard values and dimensions of capacitors type KNM80xx

Capacitance	Approvals	 P2 EN 60252-1	 C22.2 No.190
	Voltage Climate class	420 VAC 30.000 h 470 VAC 10.000 h 50/60 Hz 25/85/21	450 VAC 50/60 Hz 10.000 AFC -25/+85 °C
	Type	KNM8010, KNM8011 KNM8016, KNM8017	
C (µF)	D × H (mm)	KNM8014, KNM8015 (D ≥ 30 mm)	
1	25 × 56	•	
1,5	25 × 56	•	
2	25 × 56	•	
2,5	25 × 56	•	
3	25 × 61	•	
3	30 × 56	•	•
3,5	30 × 56	•	•
4	25 × 75	•	
4	30 × 56	•	•
4,5	25 × 75	•	
4,5	30 × 61	•	•
5	25 × 75	•	
5	30 × 61	•	•
6	30 × 75	•	•
6	35 × 61	•	•
7	30 × 75	•	•
7	35 × 61	•	•
7,5	30 × 75	•	•
7,5	35 × 61	•	•
8	30 × 75	•	•
8,5	35 × 75	•	•
9	30 × 88	•	•
9	35 × 75	•	•
10	35 × 75	•	•
11	35 × 75	•	•
12	35 × 75	•	•
12,5	35 × 88	•	•
13	35 × 88	•	•
13,5	35 × 88	•	•
14	35 × 88	•	•
14	40 × 75	•	•
15	40 × 75	•	•

Capacitance	Approvals	 P2 EN 60252-1	 C22.2 No.190
	Voltage Climate class	420 VAC 30.000 h 470 VAC 10.000 h 50/60 Hz 25/85/21	450 VAC 50/60 Hz 10.000 AFC -25/+85 °C
	Type	KNM8010, KNM8011 KNM8016, KNM8017	
C (µF)	D × H (mm)	KNM8014, KNM8015 (D ≥ 30 mm)	
16	40 × 75	•	•
18	35 × 100	•	•
18	40 × 88	•	•
20	40 × 88	•	•
22	40 × 88	•	•
25	40 × 100	•	•
25	45 × 88	•	•
30	45 × 100	•	•

Standard values and dimensions of capacitors type KNM90xx

Capacitance	Approvals	P2 EN 60252-1	C  us C22.2 No.190
	Voltage Climate class	300 VAC 50/60 Hz 10.000 h 25/85/21	300 VAC 50/60 Hz 10.000 AFC -25/+85 °C
C (µF)	Type	KNM9010, KNM9011 KNM9016, KNM9017	
	D × H (mm)	KNM9014, KNM9015 (D ≥ 30 mm)	
1	25 × 56		
1,5	25 × 56		
2	25 × 56		
2,5	25 × 56		
3	25 × 56		
3,15	25 × 56		
3,5	25 × 56		
4	25 × 65		
4,5	25 × 56		
5	25 × 56		
6	25 × 61		
6,5	25 × 61		
7	25 × 75		
7	30 × 56		•
8	25 × 75		
8	30 × 56		•
9	25 × 75		
9	30 × 61		•
10	25 × 80		
10	30 × 61		•
12	30 × 75		•
12	35 × 61		•
12,5	30 × 75		•
13	30 × 75		•
13,5	30 × 75		•
13,5	35 × 61		•
14	30 × 75		•
15	30 × 75		•
16	30 × 80		•
16	35 × 61		•
18	30 × 88		•
20	35 × 75		•

Capacitance	Approvals	P2 EN 60252-1	C  us C22.2 No.190
	Voltage Climate class	300 VAC 50/60 Hz 10.000 h 25/85/21	300 VAC 50/60 Hz 10.000 AFC -25/+85 °C
C (µF)	Type	KNM9010, KNM9011 KNM9016, KNM9017	
	D × H (mm)	KNM9014, KNM9015 (D ≥ 30 mm)	
22	35 × 75		•
24	35 × 80		•
25	35 × 80		•
30	35 × 125		•
30	40 × 100		•
35	40 × 100		•
40	40 × 125		•
40	45 × 100		•
45	45 × 75		•
45	45 × 100		•
50	45 × 109		•
50	50 × 100		•

Motor Running Capacitors

Type KNM12xx

Type KNM22xx

Type KNM32xx

Safety class **P0**



TECHNICAL DATA

Rated voltage U_n :	as per table
Rated capacitance C_n :	as per table
Capacitance tolerance:	$\pm 10\%$ ($\pm 5\%$ on request)
Rated frequency f_n :	50 Hz
Loss angle $\tan\delta$:	$< 10 \times 10^{-4}$ at U_n at 1 kHz 1V
Test voltage terminal to terminal:	$2 \times U_n$, 50 Hz, 2 s
Class of operation:	as per table
Climate class:	according to EN 60252-1
Temperature range:	- 25 °C to + 85 °C
Allowed pulse loading:	$\leq 1 \mu\text{F}$, 100 V/ μs ; $> 1 \mu\text{F}$, 50 V/ μs
Compliance with standards:	EN 60252-1, UL 810 CSA C22.2 No. 190

Design

Motor running capacitors type KNM12xx, KNM22xx and KNM32xx are made of metalized polypropylene film.

The protection against climatic and mechanical influences is reached by using prismatic plastic case sealed with epoxy resin. The case and the resin are self-extinguishing. Leads are designed as tinned copper wire or insulated copper wires.

Note: Capacitors **KNM12xx**, **KNM22xx** and **KNM32xx** can be used also for other purposes, such as in industrial electronics in electronics circuits where capacitors are lower pulse loaded.

Standard designs of capacitors type KNM12xx, KNM22xx and KNM32xx

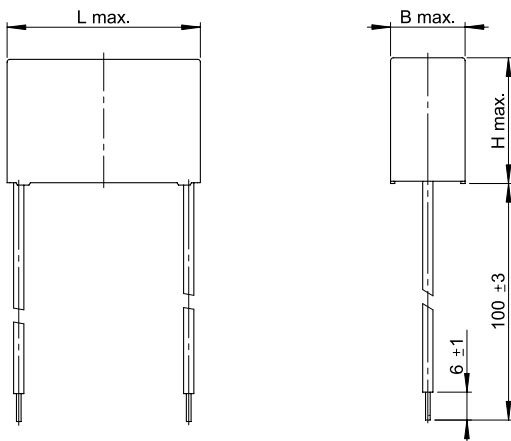

KNM1225, 1244, 2225, 2244, 3225, 3244



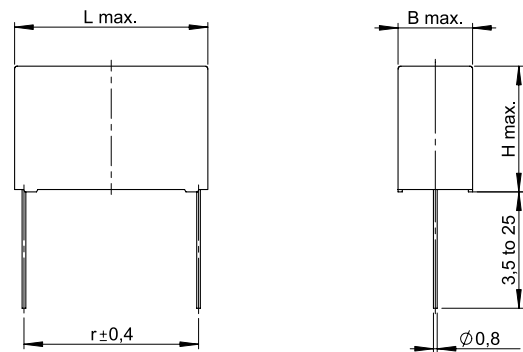

KNM1228, 2228, 3228





Standard values and dimensions of capacitors type KNM12xx

Capacitance C (µF)	Approvals		 P0 EN 60252-1		 CULUS C22.2 No.190
	Voltage		275 VAC	400 VAC	400 VAC
	Climate class		50/60 Hz 10.000 h 25/85/21	50/60 Hz 3.000 h 25/85/21	50/60 Hz -25/+85°C
	b × h × l (mm)	r (mm)			
0,33	7,5 × 16,5 × 26,5	22,5	•		•
0,47	9,0 × 18,5 × 26,5	22,5	•		•
0,68	11,0 × 20,5 × 26,5	22,5	•		•
0,82	11,0 × 20,0 × 32,0	27,5	•		•
1	11,0 × 20,0 × 32,0	27,5	•		•
1,2	11,0 × 20,0 × 32,0	27,5	•		•
1,3	14,0 × 20,0 × 32,0	27,5	•		•
1,4	14,0 × 20,0 × 32,0	27,5	•		•
1,5	14,0 × 20,0 × 32,0	27,5	•		•
1,6	13,0 × 22,0 × 32,0	27,5	•		•
1,8	15,0 × 24,5 × 32,0	27,5	•		•
2	15,0 × 24,5 × 32,0	27,5	•	•	•
2	14,0 × 25,0 × 38,5	35	•	•	•
2,2	15,0 × 24,5 × 32,0	27,5	•	•	•
2,2	14,0 × 25,0 × 38,5	35	•	•	•
2,5	14,0 × 25,0 × 38,5	35	•	•	•
2,7	14,0 × 25,0 × 38,5	35	•	•	•
2,8	14,0 × 25,0 × 38,5	35	•	•	•
3	14,0 × 25,0 × 38,5	35	•	•	•
3	14,0 × 25,0 × 41,5	37,5	•	•	•
3,2	16,0 × 27,0 × 41,5	37,5	•	•	•
3,5	16,0 × 27,0 × 41,5	37,5	•	•	•
4	16,0 × 27,0 × 41,5	37,5	•	•	•
4,5	18,0 × 31,0 × 41,5	37,5	•	•	•
5	18,0 × 31,0 × 41,5	37,5	•	•	•
5	24,0 × 26,5 × 41,5	37,5	•	•	•
5,5	24,0 × 26,5 × 41,5	37,5	•	•	•
6	24,0 × 26,5 × 41,5	37,5	•	•	•
6,5	33,0 × 35,0 × 41,5	37,5	•	•	•
7	33,0 × 35,0 × 41,5	37,5	•	•	•
7,5	33,0 × 35,0 × 41,5	37,5	•	•	•
8	33,0 × 35,0 × 41,5	37,5	•	•	•
9	33,0 × 35,0 × 41,5	37,5	•	•	•
10	33,0 × 35,0 × 41,5	37,5	•	•	•

Standard values and dimensions of capacitors type KNM22xx

Capacitance C (µF)	Approvals		 P0 EN 60252-1	 C22.2 No. 190
	Voltage		400 VAC	400 VAC
	Climate class		50/60 Hz 30.000 h 25/85/21	50/60 Hz -25/+85°C
	b × h × l (mm)	r (mm)		
0,33	10,0 × 19,0 × 31,5	27,5	•	•
0,33	11,0 × 20,5 × 26,5	22,5	•	•
0,39	11,0 × 20,0 × 32,0	27,5	•	•
0,47	12,0 × 21,0 × 31,5	27,5	•	•
0,56	11,0 × 20,0 × 32,0	27,5	•	•
0,62	11,0 × 20,0 × 32,0	27,5	•	•
0,68	11,0 × 20,0 × 32,0	27,5	•	•
0,75	12,0 × 21,0 × 31,5	27,5	•	•
0,82	13,0 × 22,0 × 32,0	27,5	•	•
1	14,0 × 25,0 × 38,5	35	•	•
1	14,0 × 23,5 × 31,5	27,5	•	•
1,2	14,0 × 25,0 × 38,5	35	•	•
1,5	14,0 × 25,0 × 38,5	35	•	•
1,8	16,0 × 27,0 × 41,5	37,5	•	•
2	16,0 × 27,0 × 41,5	37,5	•	•
2,2	16,0 × 27,0 × 41,5	37,5	•	•
2,5	18,0 × 31,0 × 41,5	37,5	•	•
2,6	18,0 × 31,0 × 41,5	37,5	•	•
2,7	18,0 × 31,0 × 41,5	37,5	•	•
3	24,0 × 26,5 × 41,5	37,5	•	•
3,5	33,0 × 35,0 × 41,5	37,5	•	•
4	33,0 × 35,0 × 41,5	37,5	•	•
4,5	33,0 × 35,0 × 41,5	37,5	•	•
5	33,0 × 35,0 × 41,5	37,5	•	•

Standard values and dimensions of capacitors type KNM32xx

Capacitance C (μF)	Approvals		 P0 EN 60252-1	 US C22.2 No. 190
	Voltage		400 VAC 30.000 h 460 VAC 10.000 h	450 VAC
	Climate class		50/60Hz 40/85/56	50/60 Hz -40/+85°C
	b × h × l (mm)	r (mm)		
0,33	11,0 × 20,5 × 26,5	22,5	•	•
0,33	10,0 × 19,0 × 31,5	27,5	•	•
0,39	11,0 × 20,0 × 32,0	27,5	•	•
0,47	11,0 × 20,5 × 26,5	22,5	•	•
0,50	10,0 × 18,5 × 26,5	22,5	•	•
0,56	11,0 × 20,5 × 26,5	22,5	•	•
0,62	11,0 × 20,5 × 26,5	22,5	•	•
0,68	10,0 × 19,0 × 31,5	27,5	•	•
0,75	11,0 × 20,0 × 32,0	27,5	•	•
0,82	11,0 × 20,0 × 32,0	27,5	•	•
1	12,0 × 21,0 × 31,5	27,5	•	•
1,2	14,0 × 23,5 × 31,5	27,5	•	•
1,5	15,0 × 24,5 × 32,0	27,5	•	•
1,8	17,0 × 26,5 × 31,5	27,5	•	•
2	17,0 × 26,5 × 31,5	27,5	•	•
2,2	14,0 × 25,0 × 41,5	37,5	•	•
2,5	16,0 × 27,0 × 41,5	37,5	•	•
2,6	16,0 × 27,0 × 41,5	37,5	•	•
2,7	16,0 × 27,0 × 41,5	37,5	•	•
3	18,0 × 26,0 × 41,5	37,5	•	•
3,5	18,0 × 31,0 × 41,5	37,5	•	•
4	24,0 × 26,5 × 41,5	37,5	•	•
4,5	33,0 × 35,0 × 41,5	37,5	•	•
4,5	29,0 × 31,0 × 41,5	37,5	•	•
5	33,0 × 35,0 × 41,5	37,5	•	•
5	29,0 × 31,0 × 41,5	37,5	•	•
5,5	33,0 × 35,0 × 41,5	37,5	•	•
5,5	29,0 × 31,0 × 41,5	37,5	•	•
6	33,0 × 35,0 × 41,5	37,5	•	•
6	29,0 × 31,0 × 41,5	37,5	•	•
6,3	33,0 × 35,0 × 41,5	37,5	•	•
7	33,0 × 35,0 × 41,5	37,5	•	•
8	33,0 × 35,0 × 41,5	37,5	•	•

• - Approved

Motor Running Capacitors

Type KNM31xx

Safety class **P0**

TECHNICAL DATA

Rated voltage U_n :	as per table
Rated capacitance C_n :	as per table
Capacitance tolerance:	$\pm 10\%$ ($\pm 5\%$ on request)
Rated frequency f_n :	50 to 60 Hz
Loss angle $\tan\delta$:	max. 10×10^{-4} at U_n and 50 Hz
Test voltage terminal to terminal:	$2 \times U_n$, 50 Hz, 2 s
Test voltage terminal to case:	2400 V, 50 Hz, 2 s
Class of operation:	as per table
Climate class:	according to EN 60252-1
Temperature range:	- 25 °C to + 85 °C
Compliance with standards:	EN 60252-1, UL 810 CSA C22.2 No. 190





Design



Motor running capacitors type KNM31xx are made of metallized polypropylene film. Case and cover are made with self-extinguishing plastic material, the capacitive element is sealed with polyurethane or epoxy resin. Leads are designed as soldering tags, single or double fast-on tags, two-wire cable, stranded wire or solid wire.

Standard designs of capacitors type KNM31xx

With bolt	KNM3111	KNM3117	KNM3115	KNM3138	KNM3126	KNM3147
Without bolt	KNM3110	KNM3116	KNM3114	KNM3137	KNM3125	KNM3144
Fast Fix	KNM3101	KNM 3107	KNM3105	KNM3108	KNM3106	KNM3104



Standard values and dimensions of capacitors type KNM31xx - motor running: 400 VAC 30.000 h



Capacitance	Approvals	 PO EN 60252-1		 us C22.2 No.190
	Voltage	400 VAC 50/60 Hz	450 VAC 50/60 Hz	450 VAC 50/60 Hz
	Climate class	30.000 h 25/85/21	10.000 h 25/85/21	-25/+85°C
	C (µF)	D x H (mm)		
1	25 x 57	•	•	•
1,25	25 x 57	•	•	•
1,5	25 x 57	•	•	•
2	25 x 57	•	•	•
2,5	25 x 57	•	•	•
3	25 x 57	•	•	•
3,15	25 x 57	•	•	•
3,15	30 x 57	•	•	•
3,5	30 x 57	•	•	•
4	30 x 57	•	•	•
4,5	30 x 57	•	•	•
5	30 x 57	•	•	•
5,5	35 x 57	•	•	•
6	30 x 71	•	•	•
6	35 x 57	•	•	•
6,3	30 x 71	•	•	•
6,3	35 x 57	•	•	•
6,8	35 x 57	•	•	•
7	30 x 71	•	•	•
7	35 x 57	•	•	•
7,5	30 x 71	•	•	•
7,5	35 x 57	•	•	•
8	35 x 57	•	•	•
9	35 x 71	•	•	•
10	35 x 71	•	•	•
11	35 x 71	•	•	•
12	35 x 71	•	•	•
12,5	40 x 71	•	•	•
13	40 x 71	•	•	•
14	40 x 71	•	•	•
15	35 x 95	•	•	•
15	40 x 71	•	•	•
16	35 x 95	•	•	•
16	40 x 71	•	•	•
17	45 x 71	•	•	•
17,5	35 x 95	•	•	•
17,5	45 x 71	•	•	•

Capacitance	Approvals	 PO EN 60252-1		 us C22.2 No.190
	Voltage	400 VAC 50/60 Hz	450 VAC 50/60 Hz	450 VAC 50/60 Hz
	Climate class	30.000 h 25/85/21	10.000 h 25/85/21	-25/+85°C
	C (µF)	D x H (mm)		
18	40 x 95	•	•	
18	45 x 71	•	•	•
20	40 x 95	•	•	
20	45 x 71	•	•	•
22	40 x 95	•	•	•
25	40 x 95	•	•	•
30	45 x 95		•	•
31,5	45 x 95		•	•
35	45 x 120			•
36	45 x 120			•
40	45 x 120			•
45	45 x 120			•
50	50 x 120			•
55	50 x 120			•
60	55 x 120			•
65	55 x 120			•
70	55 x 120			•
75	60 x 120			•
80	60 x 120			•
90	65 x 120			•
100	65 x 120			•

• - Approved



Standard values and dimensions of capacitors type KNM31xx - motor running: 400 VAC 10.000 h

Capacitance C (µF)	Approvals	 P0 EN 60252-1		 C22.2 No.190
	Voltage	400 VAC 50/60 Hz	450 VAC 50/60 Hz	450 VAC 50/60 Hz
	Climate class D x H (mm)	10.000 h 25/85/21	3.000 h 25/85/21	-25/+85°C
0,5	25 x 57	•	•	•
1	25 x 57	•	•	•
1,5	25 x 57	•	•	•
2	25 x 57	•	•	•
2,5	25 x 57	•	•	•
3	25 x 57	•	•	•
3,15	25 x 57	•	•	•
3,5	25 x 57	•	•	•
4	30 x 57	•	•	•
4,5	30 x 57	•	•	•
5	30 x 57	•	•	•
5,5	30 x 57	•	•	•
6	30 x 57	•	•	•
6,3	30 x 57	•	•	•
6,8	30 x 57	•	•	•
7	30 x 57	•	•	•
7,5	30 x 71	•	•	•
7,5	35 x 57	•	•	•
8	30 x 71	•	•	•
8	35 x 57	•	•	•
8,5	30 x 71	•	•	•
9	30 x 71	•	•	•
9	35 x 57	•	•	•
10	30 x 71	•	•	•
10	35 x 57	•	•	•
11	30 x 71	•	•	•

Capacitance C (µF)	Approvals	 P0 EN 60252-1		 C22.2 No.190
	Voltage	400 VAC 50/60 Hz	450 VAC 50/60 Hz	450 VAC 50/60 Hz
	Climate class D x H (mm)	10.000 h 25/85/21	3.000 h 25/85/21	-25/+85°C
12	35 x 71	•	•	•
12,5	35 x 71	•	•	•
13	35 x 71	•	•	•
14	35 x 71	•	•	•
15	35 x 71	•	•	•
16	40 x 71	•	•	•
18	40 x 71	•	•	•
20	40 x 71	•	•	•
22	35 x 95	•	•	•
22	40 x 71	•	•	•
25	40 x 95	•	•	•
30	40 x 95	•	•	•
40	45 x 95	•	•	•

• - Approved

Standard values and dimensions of capacitors type KNM31xx - motor running: 250 VAC 10.000 h

Capacitance	Approvals	 P0 EN 60252-1	 C22.2 No.190
	Voltage	250 VAC 50/60 Hz	250 VAC 50/60 Hz
	Climate class	10.000 h 25/85/21	-25/+85°C
C (µF)	D x H (mm)		
1	25 x 57	•	•
1,5	25 x 57	•	•
2	25 x 57	•	•
2,5	25 x 57	•	•
3	25 x 57	•	•
3,2	25 x 57	•	•
3,5	25 x 57	•	•
4	25 x 57	•	•
4,5	25 x 57	•	•
5	25 x 57	•	•
6	25 x 57	•	•
6,3	30 x 57	•	•
7	30 x 57	•	•
7,5	30 x 57	•	•
8	30 x 57	•	•
9	30 x 57	•	•
10	30 x 57	•	•
11	35 x 57	•	•
12	35 x 57	•	•
12,5	35 x 57	•	•
13	35 x 57	•	•
13,5	35 x 57	•	•
14	35 x 57	•	•
15	35 x 57	•	•
16	35 x 71	•	•
17,5	35 x 71	•	•
18	35 x 71	•	•
20	35 x 71	•	•
22	35 x 71	•	•
25	40 x 71	•	•
30	40 x 71	•	•
40	40 x 95	•	•
50	45 x 95	•	•

• - Approved

Motor Starting Capacitors

Type KNM31xx

Safety
class **P0**



Design

Motor starting capacitors type KNM31xx are made of metallized polypropylene film. Case is made of self-extinguishing plastic material, the capacitive element is sealed with polyurethane or epoxy resin. Leads are designed as two-wire cable.

TECHNICAL DATA

Rated voltage U_n :	280 VAC
Capacitance ($C_{min} - C_{max}$):	as per table
Rated frequency f_n :	40 to 60 Hz
Test voltage terminal to terminal:	$1,3 \times U_n$, 50 Hz, 2 s
Test voltage terminal to case:	2400 V, 50 Hz, 2 s
Temperature range:	- 25 °C to + 70 °C
Duty cycle:	3/1.7 % Hours applications $N = 20$ Application time $t = 3$ s $N \times t = 60$

Standard designs of capacitors type KNM31xx

With bolt	KNM3138
Without bolt	KNM3137

Two-wire cable 2 x 0.75 mm²

Standard values and dimensions of capacitors type KNM31xx - motor starting

Capacitance	
$C_{min} - C_{max}$ (μF)	D x H (mm)
50 - 63	45 x 95
63 - 80	45 x 120
80 - 100	45 x 120
100 - 125	50 x 120
108 - 132	55 x 120
125 - 156	55 x 120
156 - 200	60 x 120

Type designation data:

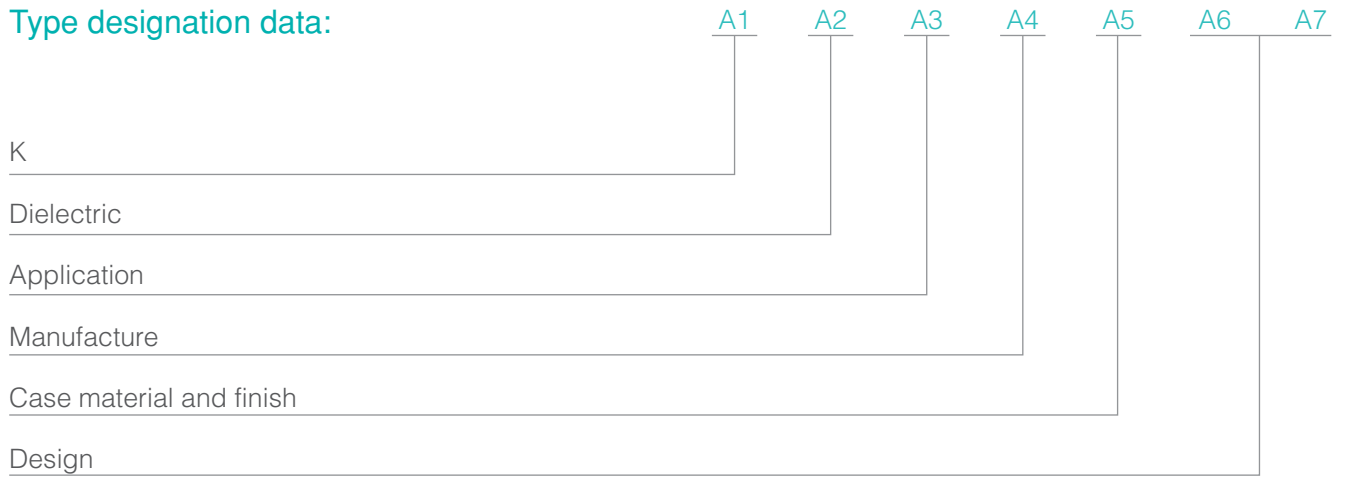

A1	K	Capacitor	
A2	N	Dielectric metallized polypropylene film	
A3	M	Motor running	
A4	1, 2, 3	in casing sealed with epoxy or polyurethanic resin	
	5, 7, 8	in casing impregnated, closed with plastic cover, mechanical disconetor incorporated	
A5	0	aluminium, cylindrical	
	1	plastic, cylindrical	
	2	plastic, prismatic	
A6	01	soldering tags 3.0x0.8 mm,FAST FIX	
	04	solid wire with insulation, FAST FIX	
	05	double fast-on terminals 6.3 × 0.8 mm as per DIN 46244,FAST FIX	
	06	stranded wire with insulation, FAST FIX	
	07	single fast-on terminals 6.3 × 0.8 mm as per DIN 46244,FAST FIX	
	08	two wire insulated cable lead, FAST FIX	
	10	soldering tags 3.0 × 0.8 mm	
	11	soldering tags 3.0 × 0.8 mm, fixing bolt	
	A7	12	plastic cap, two-wire insulated cable lead
		13	plastic cap, two-wire insulated cable lead, fixing bolt
14		double fast-on terminals 6.3 × 0.8 mm as per DIN 46244	
15		double fast-on terminals 6.3 × 0.8 mm as per DIN 46244, fixing bolt	
16		single fast-on terminals 6.3 × 0.8 mm as per DIN 46244	
17		single fast-on terminals 6.3 × 0.8 mm as per DIN 46244, fixing bolt	
	25	stranded wire with insulation	
	26	stranded wire with insulation, fixing bolt	

A6	28	tinned copper wire leads of 0.8 mm diameter and 3.5 to 25 mm length
	37	two wire insulated cable lead
A7	38	two wire insulated cable lead, fixing bolt
	44	44 - solid wire with insulation
	47	47 - solid wire with insulation, fixing bolt
	51	51 - aluminium cap, two wire insulated cable lead, fixing bolt

Details according to DIN EN 60252-1

Class of operation:

The minimum total life for which the capacitor has been designed at rated duty, voltage, temperature and frequency.

Class A 30.000 hours

Class B 10.000 hours

Class C 3.000 hours

Class D 1.000 hours

Climate class:

The first number represents the lower limit, the second one represents the higher limit, the third one represents the number of days necessary to the humidity test (example:25/85/21).

Safety class:

(P2) Indicates that the capacitor type has been designed to fail in the open-circuit mode only and is protected against fire or shock hazard.

(P1) Indicates that the capacitor type may fail in the open-circuit mode or short-circuit mode and is protected against fire or shock hazard.

(P0) Indicates that the capacitor type has no specific failure protection.

CAUTION: In case of overload, they may burst or catch fire.

Other Markings

Temperature range:

- First number: - 25 °C lowest allowed ambient temperature

DEGREE OF PROTECTION (IP)

According to IEC publication 529

1 st code letter	Degree of protection Short description	2 nd code letter	Degree of protection Short description
0	Non-protected	0	Non-protected
1	Protected against solid objects greater than 50mm	1	Protected against dripping water
2	Protected against solid objects greater than 12mm	2	Protected against dripping water when tilted up to 15°
3	Protected against solid objects greater than 2.5 mm	3	Protected against spraying water
4	Protected against solid objects greater than 1.0 mm	4	Protected against splashing water
5	Dust-protected	5	Protected against water jets
6	Total dust-protected	6	Protected against water jets

- Second number: + 85 °C highest allowed ambient temperature



Disconnecter incorporated



Discharging resistor incorporated

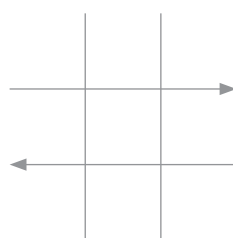

Self-healing capacitor version

to expand. One terminal, which is also weakened, cannot withstand the expansion and consequently breaks resulting in an interruption of the electrical circuit.

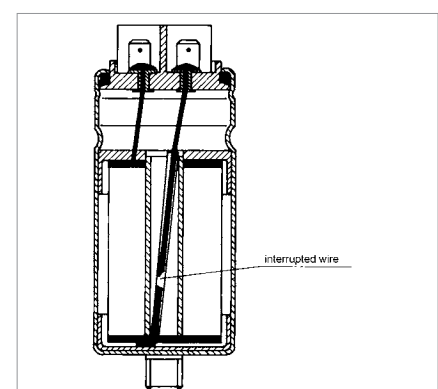
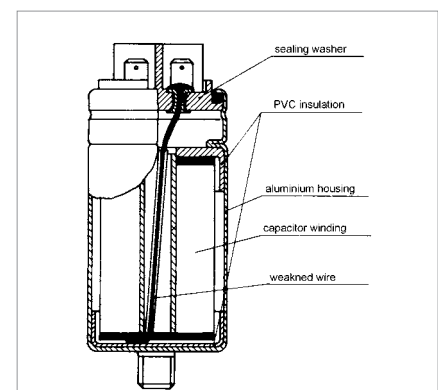

Operating of the Mechanical Disconnecter

After many breakdowns, the pressure inside the capacitor case begins to enlarge and the weaker (intended) areas of the case begin

Instructions for Ordering

When the buyer intends to order Iskra capacitors, the following data are needed:

- type designation of the capacitor
- rated voltage and rated frequency
- rated capacitance and capacitance tolerance
- class of operation
- quantity of capacitors and required lead time
- climate class

Example:

*The motor running, impregnated, cylindrical capacitor with mechanical disconnect, fast-on tags and fixing screw, for the climate class 25/85/21 and class of operation of 10000 hours, for the rated voltage 470 V 50/60 Hz, rated capacitance $10 \mu\text{F} \pm 10 \%$, is written as it is shown below:
KNM8017 $10 \mu\text{F} \pm 10 \%$ 470 VAC
50/60 Hz 10.000 h 25/85/21.*

Production Program

Capacitors for use in electronics:

- polyester film capacitors, metallized and nonmetallized
- polypropylene film capacitors, metallized and nonmetallized

Capacitors and filters for radio interference suppression

Motor running & motor starting capacitors

Power factor correction capacitors for lamps

Power factor capacitors and automatic power factor banks

Electronic regulators for power factor banks

Tools and production equipment and machinery

Lamp Power Factor Capacitors KNF

Type KNF50xx

Safety device

Applications

The capacitors type KNF are used for improvement the power factor on fluorescent, mercury, metalhallogen and sodium lamps.

With the proper choice of the capacitor in accordance with the power and lamp type the right power factor correction can be obtained.



TECHNICAL DATA

Rated voltage U_n :	250 VAC, 450 VAC
Rated capacitance C_n :	see tables
Capacitance tolerance:	$\pm 4 \%$, $\pm 5 \%$, $\pm 10 \%$
Rated frequency f_n :	50 to 60 Hz
Loss angle $\tan\delta$:	max. 10×10^{-4} at U_n and 50 Hz
Test voltage terminal to terminal:	$2 \times U_n$, 50 Hz, 2 s
Test voltage terminal to case:	2500 V, 50 Hz, 2 s
Climate class:	see tables
Temperature range:	- 25 °C to + 85 °C - 40 °C to + 100 °C, - 40 °C to + 85 °C
Compliance with standards:	EN 61048, EN 61049

The Iskra capacitors type KNF do not contain any PCB or PCN

Design

The KNF capacitors are made of metallized polypropylene film. The mechanical and climatic protection is provided by aluminium can and thermoplastic washer (type KNF50xx) or plastic can (type KNF61xx). The type KNF50xx is also protected with the mechanical disconnecter. The metallized version provides self-healing properties. This design assures long life and reliable operation.

The terminals are on the top of the capacitors in the form of soldering tags which can be used for soldering the contact wires or as the contact terminals for the screwless connector.

The following types of capacitors are available:

- with the incorporated discharging resistor
- with the fixing bolt on the bottom of the capacitor
- QUICK-FIT fixing lugs
- with the screwless connector

Standard designs of capacitor type KNF50xx

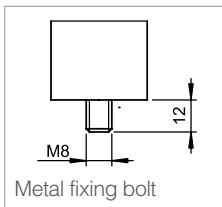
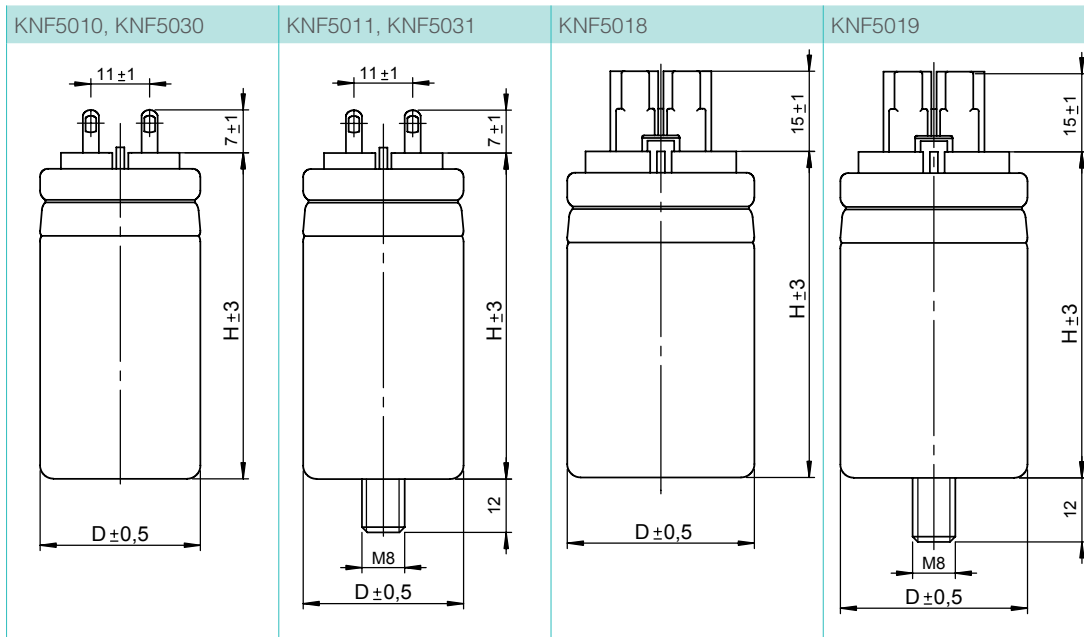

Standard values and dimensions of capacitors type KNF50xx, 250 VAC and 450 VAC

Capacitance	Voltage	250 VAC 50/60 Hz
	Climate class	40/100/21
	KNF5018, KNF5019 KNF5010, KNF5030 KNF5011, KNF5031	
C (µF)	D x H (mm)	
2	25 x 61	
2,5	25 x 61	
3	25 x 61	
3,5	25 x 61	
4	25 x 61	
4,5	25 x 88	
4,5	25 x 61	
4,5	30 x 61	
5	25 x 88	
6	25 x 88	
7	25 x 88	
7	30 x 61	
8	25 x 88	
8	30 x 88	
9	30 x 88	
10	30 x 88	
12	30 x 88	
12	35 x 76	
13,5	30 x 88	
13,5	35 x 88	
14	35 x 88	
15	35 x 88	
16	35 x 88	
18	35 x 88	
20	35 x 88	
20	40 x 88	
20	35 x 110	
21	35 x 110	
25	40 x 88	
30	45 x 88	
30	40 x 110	

Capacitance	Voltage	450 VAC 50 Hz
	Climate class	25/085/21
	KNF5018, KNF5019 KNF5010, KNF5030 KNF5011, KNF5031	
C (µF)	D x H (mm)	
2	25 x 61	
2	25 x 88	
2,4	25 x 88	
2,5	25 x 88	
2,7	25 x 88	
2,7	25 x 61	
2,8	25 x 88	
2,9	25 x 88	
3	25 x 88	
3,2	25 x 88	
3,2	30 x 61	
3,3	25 x 88	
3,4	25 x 88	
3,4	30 x 61	
3,5	25 x 88	
3,6	25 x 88	
3,7	25 x 88	
4	25 x 88	
4,4	30 x 88	
4,6	30 x 88	
5	30 x 88	
5,1	30 x 88	
5,2	30 x 88	
5,3	30 x 88	
5,4	30 x 88	
5,5	30 x 88	
5,7	30 x 88	
5,9	30 x 88	
6	30 x 88	
6,3	30 x 88	
6,8	30 x 88	
7,2	35 x 88	
7,8	35 x 88	
8,4	35 x 88	
8,7	35 x 88	
9	35 x 88	
10	35 x 88	

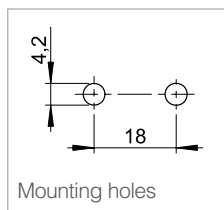
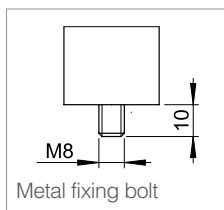
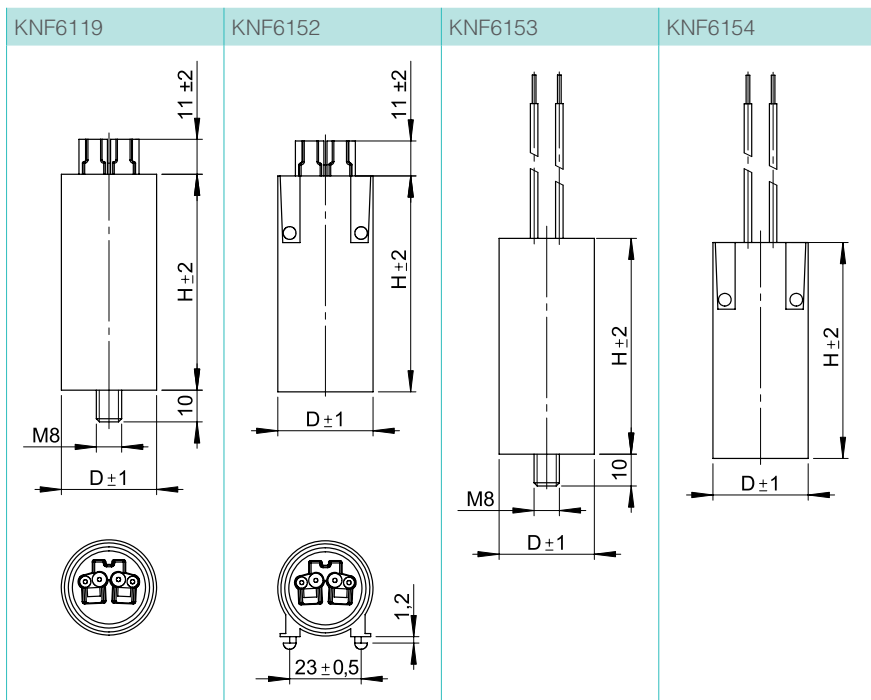

Standard values and dimensions of capacitors type KNF61xx

Capacitance	Voltage	250 VAC 50/60 Hz
	Climate class	40/85/21
	KNF6119, KNF6152 KNF6153, KNF6154	
C (µF)	D x H (mm)	
2	25 x 55	
2,5	25 x 55	
3	25 x 55	
3,15	25 x 55	
3,5	25 x 55	
4	25 x 55	
4,2	25 x 55	
4,5	25 x 68	
5	25 x 68	
5,5	25 x 68	
6	25 x 68	
6,3	25 x 68	

Capacitance	Voltage	250 VAC 50/60 Hz
	Climate class	40/85/21
	KNF6119, KNF6152 KNF6153, KNF6154	
C (µF)	D x H (mm)	
6,5	25 x 68	
6,8	30 x 68	
7	30 x 68	
7,2	30 x 68	
7,5	30 x 68	
8	30 x 68	
8,4	30 x 68	
9	30 x 68	
10	30 x 68	
11	35 x 68	
12	35 x 68	
12,5	35 x 68	

Capacitance	Voltage	250 VAC 50/60 Hz
	Climate class	40/85/21
	KNF6119, KNF6152 KNF6153, KNF6154	
C (µF)	D x H (mm)	
13	35 x 68	
13,5	35 x 68	
13,5	30 x 92	
14	35 x 68	
14	30 x 92	
15	35 x 68	
15	30 x 92	
16	35 x 68	
16	30 x 92	
18	35 x 92	
20	35 x 92	
22	35 x 92	
25	35 x 92	

Type designation data:

	A1	A2	A3	A4	A5	A6	A7
K							
Dielectric							
Application							
Manufacture							
Case material and finish							
Design							

A1	K	capacitor
A2	N	Dielectric metallized polypropylene film
A3	F	power factor correction on lamps
A4	5	impregnated, closed with plastic washer, mechanical disconnecter incorporated
	6	closed with plastic washer, dry construction
A5	0	aluminium, cylindrical
	1	plastic, cylindrical
A6 A7	10	soldering tags 3.0 × 0.8 mm
	11	soldering tags 3.0 × 0.8 mm, fixing bolt
	18	screwless connector
	19	screwless connector, fixing bolt
	30	soldering tags 3 × 0.8 mm, discharging resistor
	31	soldering tags 3 × 0.8 mm, discharging resistor, fixing bolt
	52	screwless connector, QUICK-FIT fixing lugs
	53	solid wire with insulation, fixing bolt, discharging resistor
	54	solid wire with insulation, QUICK-FIT fixing lugs, discharging resistor

Operating of the Mechanical Disconnecter

After many breakdowns, the pressure inside the capacitor case begins to enlarge and the weaker (intended) areas of the case begin to expand. One internal terminal which is also weakened, cannot withstand the expansion and consequently breaks resulting in an interruption of the electrical circuit.

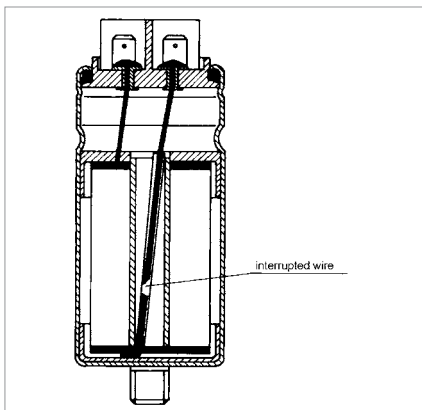
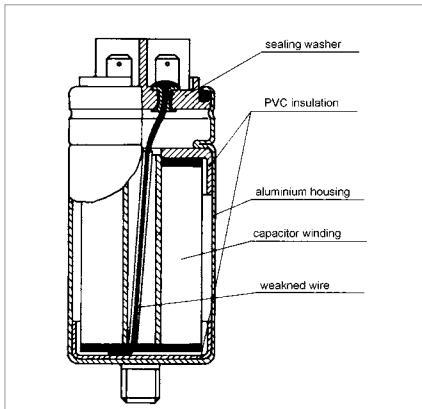

Other Markings

Temperature range:

- first number: - 25 °C, - 40 °C = the lowest allowed ambient temperature
- second number: + 85 °C, + 100 °C = the highest allowed ambient temperature



Disconnecter incorporated



Discharging resistor incorporated

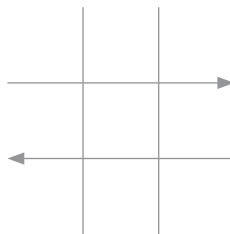

Self-healing capacitor version

Production programme

Capacitors for use in electronics

- polyester film capacitors, metallized and nonmetallized
- polypropylene film capacitors, metallized and nonmetallized

Capacitors and filters for radio interference suppression

Spark suppression capacitors for motor cars

Motor running & motor starting capacitors

Power factor capacitors for lamps

Power factor capacitors and automatic power factor banks

Electronic regulators for power factor banks

Capacitors for inductive heating

Tools and production equipment and machinery

Instructions for ordering

When ordering the following data are needed:

- the type designation of the capacitor
- the rated voltage and rated frequency
- the rated capacitance and capacitance tolerance
- the climate class
- the quantity and the required lead time

W11



Iskra MIS, d. d.

Ljubljanska c. 24a

SI-4000 Kranj, Slovenia

Phone: +386 4 23 72 112

Fax: +386 4 23 72 129

E-mail: info@iskra-mis.si

www.iskra-mis.si